

Approval body for construction products
and types of construction

Bautechnisches Prüfamt

An institution established by the Federal and
Laender Governments



European Technical Assessment

ETA-13/0517
of 3 September 2021

English translation prepared by DIBt - Original version in German language

General Part

Technical Assessment Body issuing the
European Technical Assessment:

Deutsches Institut für Bautechnik

Trade name of the construction product

CELO ceiling anchor DA

Product family
to which the construction product belongs

Fasteners for use in concrete for
redundant non-structural systems

Manufacturer

CELO Befestigungssysteme GmbH
Industriestraße 6
86551 Aichach
DEUTSCHLAND

Manufacturing plant

Werk 15

This European Technical Assessment
contains

10 pages including 3 annexes which form an integral part
of this assessment

This European Technical Assessment is
issued in accordance with Regulation (EU)
No 305/2011, on the basis of

EAD 330747-00-0601, Edition 06/2018

This version replaces

ETA-13/0517 issued on 27 February 2017

The European Technical Assessment is issued by the Technical Assessment Body in its official language. Translations of this European Technical Assessment in other languages shall fully correspond to the original issued document and shall be identified as such.

Communication of this European Technical Assessment, including transmission by electronic means, shall be in full. However, partial reproduction may only be made with the written consent of the issuing Technical Assessment Body. Any partial reproduction shall be identified as such.

This European Technical Assessment may be withdrawn by the issuing Technical Assessment Body, in particular pursuant to information by the Commission in accordance with Article 25(3) of Regulation (EU) No 305/2011.

Specific Part

1 Technical description of the product

The CELO ceiling anchor DA is an anchor made of zinc-plated steel which is placed into a drilled hole and anchored by deformation-controlled expansion.

The product description is given in Annex A.

2 Specification of the intended use in accordance with the applicable European Assessment Document

The performances given in Section 3 are only valid if the anchor is used in compliance with the specifications and conditions given in Annex B.

The verifications and assessment methods on which this European Technical Assessment is based lead to the assumption of a working life of the anchor of at least 50 years. The indications given on the working life cannot be interpreted as a guarantee given by the producer, but are to be regarded only as a means for choosing the right products in relation to the expected economically reasonable working life of the works.

3 Performance of the product and references to the methods used for its assessment

3.1 Safety in case of fire (BWR 2)

Essential characteristic	Performance
Reaction to fire	Class A1
Resistance to fire	See Annex C 1

3.2 Safety and accessibility in use (BWR 4)

Essential characteristic	Performance
Characteristic resistance for all load directions and modes of failure for simplified design	See Annex C 1

4 Assessment and verification of constancy of performance (AVCP) system applied, with reference to its legal base

In accordance with European Assessment Document EAD No. 330747-00-0601, the applicable European legal act is: [97/161/EC].

The system to be applied is: 2+

5 Technical details necessary for the implementation of the AVCP system, as provided for in the applicable European Assessment Document

Technical details necessary for the implementation of the AVCP system are laid down in the control plan deposited at Deutsches Institut für Bautechnik.

Issued in Berlin on 3 September 2021 by Deutsches Institut für Bautechnik

Dipl.-Ing. Beatrix Wittstock
Head of Section

beglaubigt:
Baderschneider

CELO ceiling anchor DA

Product

Type
DA 6-30/5

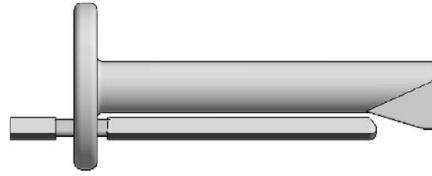

Type
DA 6-60/35

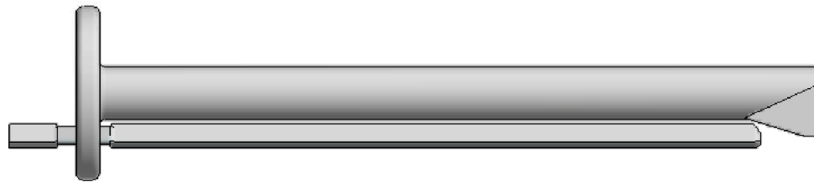

CELO ceiling anchor DA after installation

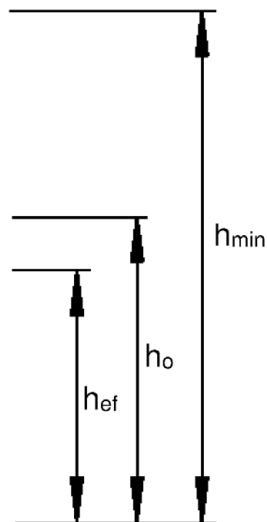
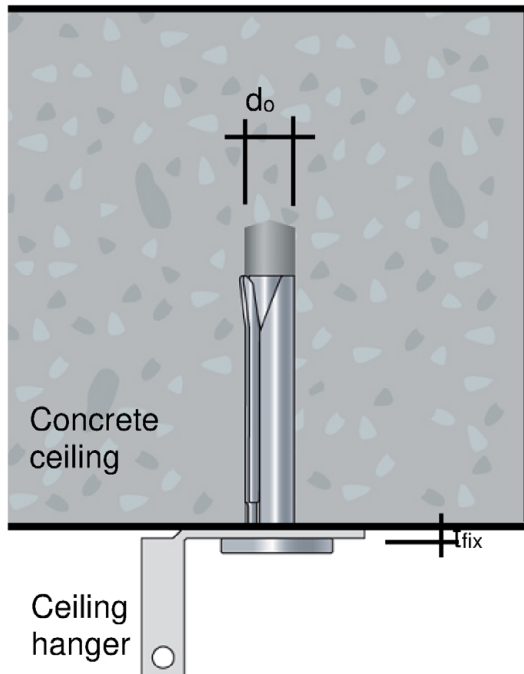

d_o = diameter of drill hole
 h_o = depth of drill hole (deepest point)
 h_{min} = min. thickness of concrete member
 t_{fix} = thickness of fixture
 h_{ef} = effective anchorage depth

CELO ceiling anchor DA

Product description
Product and installed condition

Annex A1

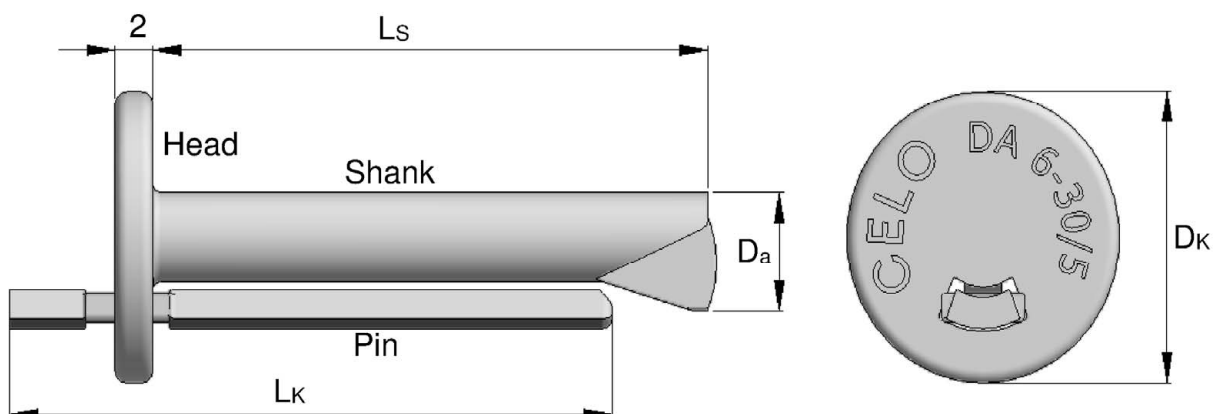

Marking:	brand marking	Logo or company name
	Type	DA
	Size/ diameter (mm)	6
	Length (mm)	L (z.B. 30)
	Max. thickness of fixture (mm)	t _{fix} (z.B. 5)

Example for marking: **CELO DA 6-30/5** or **apolo DA 6-30/5**

Table 1: designation and materials

designation	material	DA 6-30/5	DA 6-60/35
Pin	Carbon steel	C1065 or Mn65	C1065 or Mn65
Shank incl. Head	Carbon steel	C1035 or 10B21	C1035 or 10B21

All parts zinc plated and blue passivated $\geq 5 \mu\text{m}$ acc. EN ISO 4042: 2018

Table 2: dimensions

dimensions			DA 6-30/5	DA 6-60/35
Length of pin	L _k	[mm]	32	63
Length of shank	L _s	[mm]	29,5	60
Diameter head	D _k	[mm]	14,5	14,5
Diameter cone	D _a	[mm]	5,9	5,9

CELO ceiling anchor DA

Product description

Materials, marking and anchor dimensions

Annex A2

Specification of intended use

Anchorage subjected to:

- Static and quasi-static loads.
- only for use in concrete for redundant non-structural systems.
- resistance to fire.

Base materials:

- Compacted reinforced or unreinforced normal weight concrete without fibres according to EN 206:2013+A1:2016.
- Strength classes C20/25 - C50/60 according to EN 206:2013+A1:2016.
- Uncracked and cracked concrete.

Use conditions (Environmental conditions):

- Structural subject to dry internal conditions.

Design:

- Anchorages are designed under the responsibility of an engineer experienced in anchorages and concrete work.
- Verifiable calculation notes and drawings are prepared taking account of the loads to be anchored. The position of the anchor is indicated on the design drawings (e.g. position of the anchor relative to reinforcement or to supports, etc.).
- Design of fastenings according to EN 1992-4:2018 and EOTA Technical Report TR 055, Edition February 2018.

Installation:

- Anchor installation carried out by appropriately qualified personal and under the supervision of the person responsible for technical matters of the site.
- Check concrete being well compacted, e.g. without significant voids.
- Positioning of the drill holes without damaging the reinforcement.
- In case of aborted hole: new drilling at a minimum distance away of twice the depth of the aborted hole or smaller distance if the aborted hole is filled with high strength mortar and if under shear or oblique tension load it is not in the direction of load application.

CELO ceiling anchor DA

Intended use
Specifications

Annex B1

Table 3: Installation parameters

			DA 6-30/5	DA 6-60/35
Nominal diameter of drill bit	d_o	[mm]	6	6
Cutting diameter of drill bit	d_{cut}	[mm]	$\leq 6,4$	$\leq 6,4$
Depth of drill hole	$h_o \geq$	[mm]	30	30
Effective anchorage depth	$h_{ef} \geq$	[mm]	25	25
Maximal thickness of fixture	t_{fix}	[mm]	4,5	35

Table 4: Minimum thickness of concrete member, min. spacing and edge distance

			DA 6-30/5	DA 6-60/35
Minimum thickness of member	h_{min}	[mm]	80	80
Minimum spacing	s_{min}	[mm]	200	200
Minimum edge distance	c_{min}	[mm]	150	150

CELO ceiling anchor DA

Intended use

Installation parameters, min. thickness, min. spacing and edge distance

Annex B2

Installation instruction of CELO ceiling anchor DA



1. Drill the hole with a hammer drill, clean the borehole (blowing out).

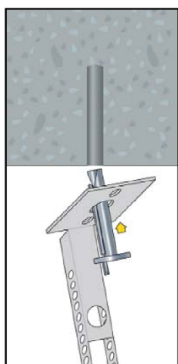

2. Insert the ceiling anchor through the opening of the part to be fixed/ceiling hanger. Afterwards, push the anchor together with the ceiling hanger into the borehole by hand.

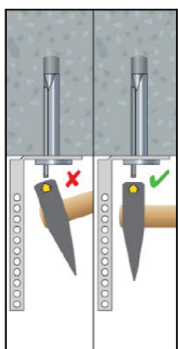

3. Move the anchor completely into the borehole by hand or using soft hammer blows until the head of the anchor lays upon the fixing part. Then adjust the fixing part/ceiling hanger.

Now hit in the pin with further hammer blows until it is flush mounted in the head.

Execute the hammer blows vertically to avoid any bending of the pin.

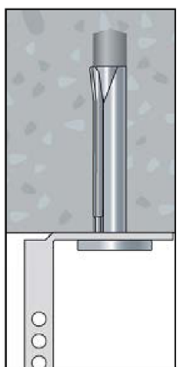

4. The ceiling anchor DA is installed. Little adjustment of the ceiling hanger is possible.

CELO ceiling anchor DA

Intended use
Installation instruction

Annex B3

Table 5: Design method C: Characteristic values for all load directions

Any load direction			DA 6-30/5	DA 6-60/35
Characteristic resistance in concrete (C20/25 to C50/60)	F_{Rk}^0	[kN]	2,0	2,0
Spacing	$s_{cr} = s_{min}$	[mm]	200	200
Edge distance	$c_{cr} = c_{min}$	[mm]	150	150
Partial factor	γ_M	[-]	1,5	1,5
Installation Factor	γ_{inst}	[-]	1,0	1,0
Shear load with lever arm				
Characteristic bending moment	$M_{Rk,s}^0$	[Nm]	8,2	8,2
Partial safety factor	γ_{Ms}	[-]	1,5	1,5

Table 6: Characteristic values under fire exposure for use in concrete C20/25 - C50/60 in any load direction

Fire resistance class				DA 6-30/5	DA 6-60/35
R30	Characteristic resistance	$F_{Rk,fi}$	[kN]	0,55	0,55
R60	Characteristic resistance	$F_{Rk,fi}$	[kN]	0,47	0,47
R90	Characteristic resistance	$F_{Rk,fi}$	[kN]	0,23	0,23
R120	Characteristic resistance	$F_{Rk,fi}$	[kN]	0,12	0,12
R30 to R120	Spacing	$s_{cr,fi}$	[mm]	200	200
	Edge distance	$c_{cr,fi}$	[mm]	150	150

CELO ceiling anchor DA

Performances

Characteristic values for all load directions and under fire exposure

Annex C1